Contents

Installation	2
Connections	5
Connecting the Communications Interface	6
Powering the Instrument.....	7
Connecting the Status Inputs.....	8
Connecting the Logic Outputs.....	8
Menu mode key functions	10
Operator Functions	12
Alarm Setpoint Edit	13
Connecting the Transducer.....	16
Configuring the Input	17
Calibration and Scaling	20
Configuring the Display	26
Configuring Alarms	28
Configuring Relay / Logic Outputs	31
Configuring the Analogue Output.....	32
Configuring Serial Communications	33
Configuring Status Inputs.....	36
Configuring Function Keys	38
System Options	39
Messages	40
Product Specification.....	42
Analogue Memory locations	44
Logic Memory locations.....	49

Introduction

This Set-up Guide describes how to install and configure your instrument.



This Instrument is marked with the international hazard symbol. It is important to read this Setup Guide before installing or commissioning your panel meter as it contains important information relating to safety and Electromagnetic Compatibility EMC.

The instruments provide the following features as standard:

- Four configurable alarms
- Scaleable Analogue Retransmission Output
- Dual Logic / Status inputs
- RS485 Serial Communications interface with three protocols including MODBUS™ RTU
- 5 digit bright LED display
- Programmable function keys
- Optional dual relay output or quad digital (TTL) outputs

Installation

To Install your instrument you will need to carry out the following steps:

- Apply the engineering units label to the right hand side of the display panel. A sheet of labels is supplied with all units, these cover most commonly used engineering units. If the unit you require is not on the sheet, a blank label is provided on which you can use LETRASET™.
- Install the instrument into a panel.
- Make connections to the instrument.

Please note:

- Ensure that the power to instrument is switched off before carrying out any installation or maintenance work.
- It is recommended that all connections to the terminals are made using ferrules to afford greater reliability and to prevent short circuits between adjacent terminals.

- Avoid installing the instrument close to switch gear, contactors or motor starters.
- Do not place signal and power supply wiring in the same loom.
- Use screened cables or wires for all signal/sensor leads with screen earthed at one point only.

Panel Mounting

Ensure that there is sufficient space behind the instrument panel for the depth of the instrument allowing for safe routing of cables. The diagram below shows a side view of the instrument showing its dimensions.

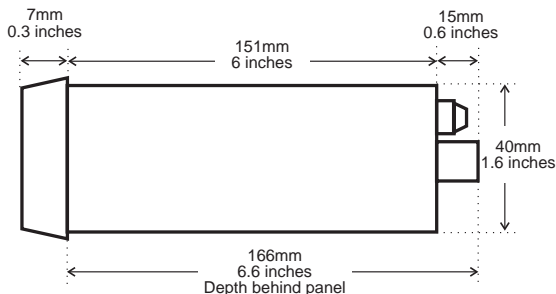

The instrument is supplied with an installation kit consisting of two mounting clamps and a panel sealing gasket. To install the instrument:

1. Make panel cut-out with dimensions as shown below. Panel thickness from 1.5mm to 9.5mm can be accommodated.

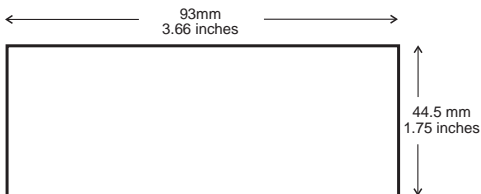

2. Fit the rubber seal by slipping it over the unit from the rear of the box pushing it forwards until it sits behind the front lip of the unit.
3. Insert the instrument into the panel from the front, pushing it through as far as the front lip, ensuring correct seating of the rubber seal between the panel and the unit.
4. Working from behind the panel take the two mounting brackets locate on to the case as shown below (note orientation of keyhole slots relative to instrument case). With the brackets located slide them backwards until they lock into place.
5. Tighten the screws until they bite into the panel securing the instrument in place. Take care not to overtighten the screws as this may damage the case of the instrument.

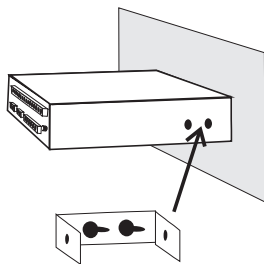

Connections

The diagram below shows the rear panel terminal connections arrangement. Note that terminals 1 to 6 are not present on some models, see table.

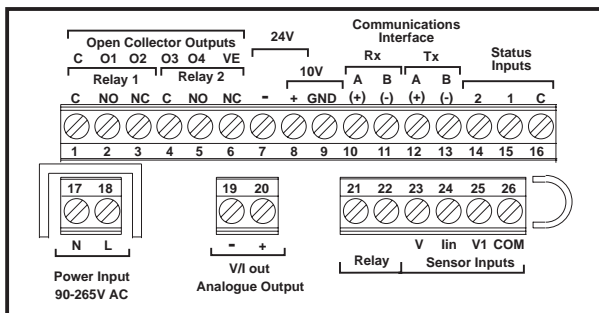

Terminal	No Alarm	Dual Relays	Quad TTL
1	None	Relay 1 - C	Output GND
2	None	Relay 1 - NO	Output 1
3	None	Relay 1 - NC	Output 2
4	None	Relay 2 - C	Output 3
5	None	Relay 2 - NO	Output 4
6	None	Relay 2 - NC	Output Supply
7	24V Transmitter Supply -ve		
8	Transducer or Transmitter Supply +ve		
9	0-12V Transducer Supply -ve		
10	Receive A		
11	Receive B		
12	Transmit A		
13	Transmit B		
14	Status (Logic) Input 1		
15	Status (Logic) Input 2		
16	Status Input Common (GND)		
17	Power input Neutral (-)		
18	Power Input Live (+)		
19	Analogue Retransmission Output -		
20	Analogue Retransmission Output +		
21	Calibration Relay C		
22	Calibration relay NO		

23	10V Input
24	mA Current Shunt
25	mV Sensor Input
26	Input Common

Connecting the Communications Interface

The diagrams below show the connections necessary to interface your instrument to a PC RS485 / 422 port or to an RS485 to RS232 Converter. It is recommended that screened twisted pair cable be used for all applications requiring cable lengths greater than 3m. It is also recommended that a 120Ω termination resistor is added to across each pair of wires at the furthest point from the master device. The screen of the cable should be connected to the Frame Ground or Ground connection of the Master device. The diagram below shows the wiring required for both 4 wire full duplex and 2 wire half duplex installations.

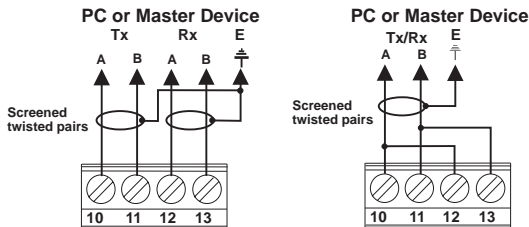

4 wire and 2 wire Communications Interface Connections

Powering the Instrument

THERE ARE 2 SUPPLY VARIANTS: a mains supply variant and a low voltage supply variant. The instrument is designed to operate from either an AC supply with voltages in the range 90 to 230V AC 50/60Hz mains supply or from a DC supply with voltages in the range 24 to 32V DC (20 to 30V AC) 50/60Hz low voltage supply with a maximum power consumption of 20VA when all outputs are fully loaded and the display has all segments illuminated.

The diagrams below show how the instrument should be connected to the mains supply. Isolation should be provided by a double pole switch and a time delay 200mA fuse.

WARNING - The instrument is designed for installation in an enclosure which provides adequate protection against electric shock. Access to power terminals should be restricted to authorised skilled personnel only. Application of supply voltages higher than those for which the instrument is intended may compromise safety and cause permanent damage.

Recommended Mains Supply Connections

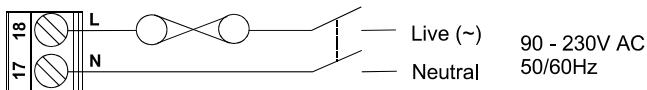

Recommended Low Voltage Supply Connections

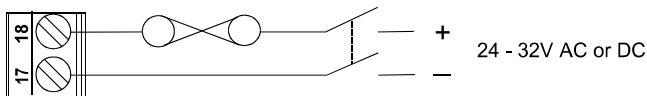

BEFORE POWERING UP THE INSTRUMENT, check the model label on the underside of the instrument for the supply variant, eg. MAINS OR LOW VOLTAGE.

Connecting the Status Inputs

There are two status (logic) inputs provided by your instrument. The inputs can be used with either voltage free contacts such as relay contacts, switches, open collector transistor outputs or voltage driven. The inputs are active low i.e. applying a short circuit between the status input and status common. The diagrams below show some typical applications. Note that these inputs are not isolated from the instruments input circuit.

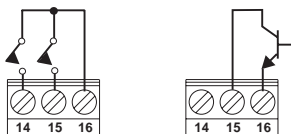

Connecting the Logic Outputs

Connecting to External Logic Inputs

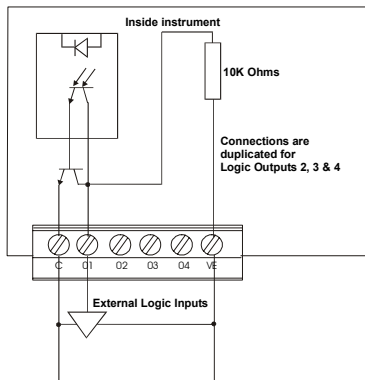

Connecting to External Relays

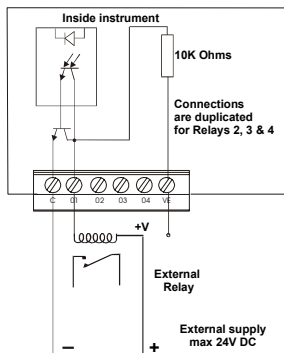

Menu mode key functions

The instrument may be configured using the front panel keypad to enter and navigate through the multi level menu structure. When navigating through the menu's, the front panel keys perform the following functions:



Used to select or access a sub menu



Used to scroll forward through the menu's



Used to scroll backwards through a menu



Moves back up to the previous menu Multiple key presses will always return the instrument to the measured value display.

At the edit or entry level of the menu's there are two ways of setting or changing parameters, selection from a list of options or by editing a numeric value directly.

Option Edit Mode

During option edit mode selected from the menu's the left hand digit of the current option will flash indicating edit mode. When in option edit mode the front panel keys perform the following functions:



Selects the currently flashing option as the new setting and exits the option list back to the menu's.



or  Move up or down the list of options.

Numeric Value Entry Mode

On entry to edit a parameter that is a numeric value the LSD (Least Significant Digit) of the current value will be flashing, this is the currently editable digit. To change the value of the editable digit use the UP and DOWN arrow keys to increment or decrement the digit. To select the next digit to edit use the next key (far left), which will move to the next digit which will flash. Using the NEXT and UP and DOWN arrow keys the value can be changed to any number within the valid display range of the instrument or within the limits of the parameter. For some values the position of the decimal point may be

changed when this is possible the decimal point will flash when the NEXT key is pressed after editing the MSD (Most Significant Digit). To enter a negative value the MSD may be used to enter - or -1. When editing numeric values the front panel keys perform the following functions:



Enter value and exit from edit or entry mode



Selects the next digit (flashing) or decimal point (flashing) to be edited



Increments the current digit being edited (or moves decimal point position)



Decrements the current digit being edited (or moves decimal point position)



Clears a numeric value to zero

Operator Functions

All of the operator functions are described in the following section along with the key actions required. The diagram below shows the facilities available directly from the operator (normal) display mode.

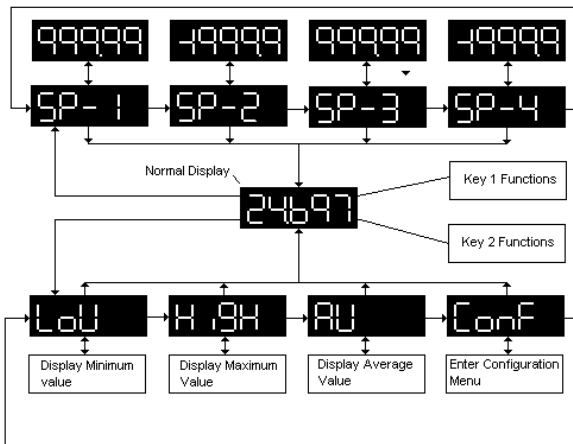

Operator mode key functions





Enter - Allows access to the operator functions the low, high (peak) and average values since the last reset and Configuration mode (Set-up mode). To access the operator functions press and hold for approximately 5 seconds until LOW is displayed.



Next - Function key 1, can be configured to perform various functions such as FAST CAL, display zeroing or display tare. Details of the facilities available and how to configure the key are described later in this guide.

 **Down** - Accesses the four Alarm Setpoints for viewing and editing if enabled (see section on enable alarm parameters on how to enable / disable front panel edit mode).

 **Up** - Exits from alarm setpoint menus to normal running.

 **Star** - Function key 2 can be configured to perform various functions. Details of the facilities available and how to configure the key are described later in this guide..

 **Up and Down Arrows** - Pressed together will perform an Alarm Acknowledge for latched alarms.

Alarm Setpoint Edit

Each of the four alarm setpoints may be edited from the front panel without having to enter the configuration menu's. This facility may be disabled as part of the alarm set-up (Configuring Alarms, Front Panel Edit). When front panel alarm edit has been selected by pressing the DOWN key you can select the required setpoint to edit by pressing the NEXT key. To view an alarm setpoint press the DOWN key when the display shows the required setpoint, to exit setpoint view mode press the DOWN key. To edit an alarm setpoint if this facility is enabled press the ENTER key. The display will show the setpoint value with the Least Significant digit flashing to indicate the current edit digit. To change the setpoint the value is edited using the same procedure as for all other numeric values

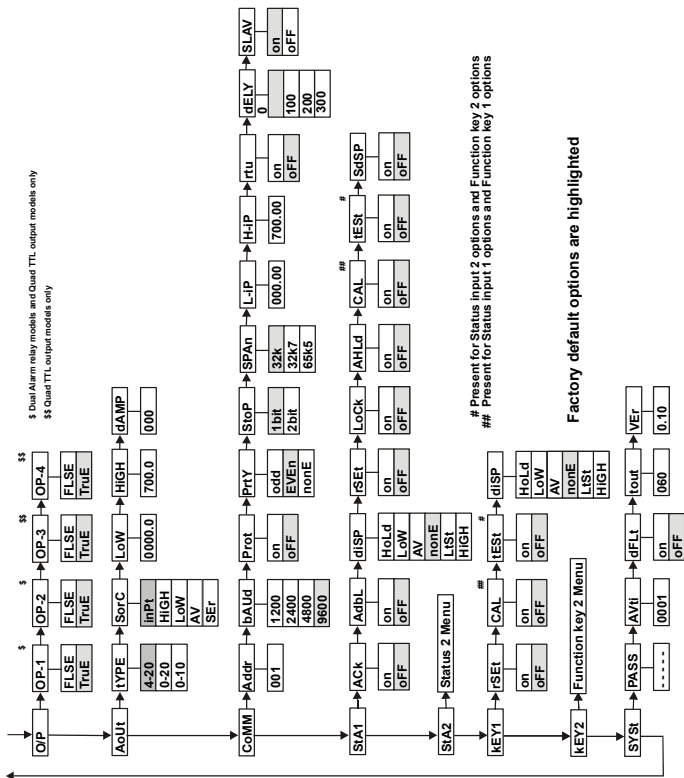

Connecting the Transducer

The transducer should be connected to the instrument as illustrated in the diagrams below. The instrument is designed to operate with both passive (bridge type) and active (conditioned, amplified) transducers. When connecting to a passive transducer the maximum output from the transducer at the required excitation voltage must not exceed the input range of the instrument which is $\pm 100\text{mV}$. The connections shown below include those required to make use of the automatic calibration facility. When making connections to the transducer use a screened cable with the screen connected to ground at one point only. Avoid running signal cables close to cables carrying high current or voltages or those connected to motor drives or contactors.

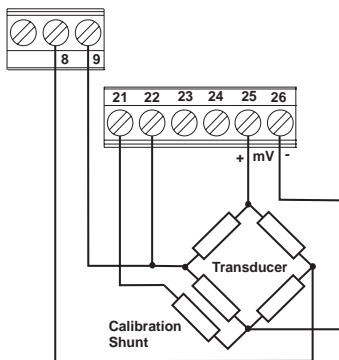

Passive Bridge Transducer Connections

The millivolt input of the instrument may also be used to measure voltage directly and may be connected to any voltage source capable of output in the range $\pm 100\text{mV}$.

To measure current the instrument's internal current sense must be connected by linking terminal 24 to 25, the internal shunt is typically 5Ω and is rated at 0.25W (See diagram overleaf).

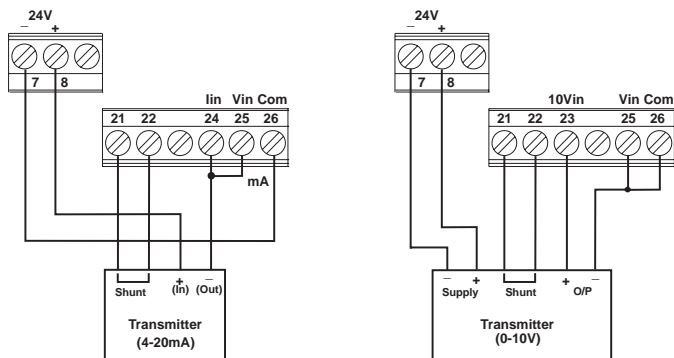

Typical 4 -20mA and 0-10V Transmitter Connections

Configuring the Input

Introduction



Before any calibration or scaling operations are performed some operating parameters related to the use of the particular transducer need to be set up. These parameters are all set up from the input menu.

Input Type

(Analogue-62)



This selects the correct input type depending on the type of transducer or transmitter to be connected. For a passive bridge transducer the input type mV would normally be selected. The option for input type are mV, $\pm 100\text{mV}$ input, mA which allows the unit to operate with active 20mA pressure transmitters and Volts for signals in the range $\pm 10\text{Vdc}$. The default is mV.

Transducer zero output

(Analogue-63)

A digital display showing the text 'ZER0' in a white, monospaced font on a black background.

This value should be entered in the appropriate units i.e. mV, mA or Volts depending on which input type the instrument has been configured for and the type of transducer to be connected. The value to be entered should be part of the data supplied with the transducer and will typically be quoted as 'zero output' or 'zero offset' and is the transducer output at zero pressure. If using a 4-20mA output transducer (Transmitter) this value would be set to 4(mA).

Transducer Full Scale Output

(Analogue-64)

A digital display showing the text 'FS0' in a white, monospaced font on a black background.

This value should be entered in the appropriate units i.e. mV, mA or Volts (dependant on input type) and represents the maximum output from the transducer at the rated maximum pressure. For a passive transducer this value may be quoted as the sensitivity i.e. mV per VOLT excitation, multiplied by the excitation voltage. e.g. 3mV/V sensitivity with a 10V excitation (which is the default transducer excitation value) would require 30mV to be entered. For an active transducer (Transmitter) type i.e. 4 - 20mA output, 20(mA) would be entered. (See also TPSU menu).

The values entered for **ZERO** and **FSO** are retained by the instrument and are used to set the initial calibration of the instrument to the transducer. They are also used to verify the characteristics and operation of the transducer when performing any subsequent calibrations using the automated facility. Automated 'FAST CAL' Calibration and how to initiate an automatic calibration is described in the next section of this guide. The unit will use these values and compare them against the actual values obtained during a calibration allowing any degradation in transducer performance or characteristics to be detected.

Transducer Excitation

(Logic-178)

A digital display showing the text 'TPSU' in a white, monospaced font on a black background.

To configure the transducer power supply select **TPSU** from the menu and enter the required excitation voltage (see section on entering numeric values). The default output voltage is set to 10V but the output may be adjusted anywhere in the range 0-12V in increments of 0.01V. The transducer

supply regulated output is provided on terminals 8 and 9. To supply an active transmitter with 24V connect between terminals 7 and 8.

Mains Frequency

(Logic-55)



This option allows you to select the mains supply frequency. The frequency selected is used to synchronise the input measurement circuits to give the best mains frequency noise rejection. The options are 50Hz (default) and 60Hz

Calibration and Scaling

Introduction

The Instruments are configurable to allow them to be used with most pressure transducers. To set-up the instrument to display pressure in the correct engineering units it is first necessary to set the low (zero) and high (full scale, span) display and transducer output values. These values are accessible from the scaling menu (see menu diagram) and may be entered numerically as a voltage or current value. The scaling parameters allow you to define the relationship between the transducer output and the values displayed for pressure in engineering units i.e, PSI.

As an alternative to entering the transducer output scaling points numerically the instrument is able to perform an automated calibration by measuring the output of the transducer directly at two known calibration points by using the CAL menu.

NOTE: Before proceeding with any calibration it is first necessary to set up the input parameters i.e. Zero and Full Scale Output values, Transducer supply voltage, input type. The Zero and FSO settings are used to verify the automated calibration and may cause a failure to occur if not set to the correct values. These values are provided with the transducers documentation

Scaling Menu (SCLE)

The image shows a black rectangular display with the white text "SCLE" inside.

The scaling menu is provided to allow the instrument to display the correct pressure values i.e. in Bar or PSI. The scale menu allows the two calibration points to be manually entered for both the display values and corresponding input values (in mV, Volts or mA dependant on input type).

Low (Zero) Display Value

(Analogue-73)

The image shows a black rectangular display with the white text "LdSP" inside.

This is the 0% or minimum pressure range of the transducer (typically 0) to be displayed by the instrument.

High Display Value

(Analogue-75)

HdSP

This display value corresponds to the pressure value corresponding to the pressure level simulated by the transducer when the internal calibration shunt resistance is connected. This simulated pressure would be typically 80% of the full range of the transducer as specified in the documentation supplied with the transducer. E.g. 0-3000 psi , LdSP = 0, HdSP = 2400 (80%).

The high and low display values are both used as part of the calibration / scaling process and should normally be entered before any calibration is performed.

High (Span) Signal Input Value

(Analogue-76)

H-I-P

This is the signal value which corresponds to the high display value and is entered in the selected signal input units i.e. mV, mA or Volts. This value may be entered numerically when selected from the Scaling menu option or measured as part of the automated calibration process when this is initiated from the Calibration (CAL) menu, or by a function key or a status input..

Low (Zero) Signal Input Value

(Analogue-74)

L-I-P

This is the signal value corresponding to the minimum output from the transducer (low display value).

Calibration menu**CAL**

The following parameters are used to calibrate your transducer, instrument and cabling as a system. The process is automatic and makes use of the transducers internal calibration shunt resistor which simulates (typically) 80% of the full range of the transducer. The calibration shunt resistor is automatically connected in circuit by the instruments calibration relay.

NOTE: During the following calibration procedure, no pressure should be applied to the transducer. For best results power the system for a minimum of 30 minutes before calibrating.

Calibration menu sequence

Main menu Calibration option, Press Enter (↵) to select.

Calibration relay is open

15 second countdown while the transducer output is measured (CAL relay open)

The measured value of the transducer output signal at zero pressure is displayed (in mV, mA or Volts dependant on signal type).
Press Enter (↵) to continue calibration.

The calibration relay is closed.
The Transducer calibration resistor is now connected.

15 second countdown while the transducer 80% output is measured by the instrument.

Measured value for 80% full scale pressure signal output from transducer is displayed value will be in mV, mA or Volts.
Press Enter (↵) to return to menu's

The low (zero) and high (typically 80% of full scale) measured outputs from the transducer are used to match the calibration of the instrument to the transducer.

If the instrument has detected an error during the calibration process the message FAIL will be displayed. This may be due to the following:-

- Faulty transducer i.e. one of the elements of the bridge open circuit
- Break in one of the connections or wires to the transducer
- Problem with the calibration shunt resistor or relay
- No transducer excitation.
- The TPSU parameter value is too low, or set at zero.
- A shift of the zero output of the transducer outside of an acceptable level. Typically a change of $> \pm 25\%$ of FSO from the initial ZERO output.
- The Calibration output (80% FSO) from the transducer is reduced below an acceptable level when compared to the initial Full Scale Output value.

If FAiL is displayed press enter (↵) to escape to the menu. The previous (or default) calibration values will be retained.

Calibration using status input 1

The unit can be configured to perform an automatic calibration in response to a status or logic input. When this facility is enabled the calibration is initiated by holding the status input active for a minimum of 1 second. The sequence followed is very similar to that followed when a calibration is performed from the Menu, with the following differences:-

- The transducer output value is not displayed after each measurement stage.
- No delay between the L-IP and H-IP calibration measurements.
- At the end of the calibration procedure the Message dOnE will be flashed on the display briefly indicating a successful calibration. The new calibration will be saved automatically and will take effect immediately. If the instrument detects a problem during the calibration process then the message FAiL will be displayed. To clear the fail message and return to normal operation press the ENTER key. The instrument will return to normal operation, retaining the previous calibration values.

Calibration using function key 1 (Next)

The NEXT key is assigned to perform a calibration sequence as the default. This facility can be enabled or disabled from the KEY1 menu. To instigate a calibration press the NEXT key, the display flashes the message CAL. To continue with calibration press the NEXT key again within 5 seconds. If the NEXT key is not pressed within the 5 seconds the instrument will revert to normal operation. Once instigated the procedure followed is the same as for status input initiation except that at the end of the process the message SAVE will be flashed. For the new calibration values to take effect the enter key must be pressed whilst SAVE is displayed. The message donE is displayed to confirm that the SAVE has been performed and the new calibration values have taken effect. If the Enter key is not pressed whilst SAVE is displayed the unit will revert to normal operation after approximately 5 seconds and the new calibration will be discarded and the previous calibration values are retained.

Testing your System

The 250 series instruments provide a facility for testing the transducer and the instrument as a system. This facility closes the calibration relay to simulate (typically) 80% of the full scale of the transducer's output. The test facility can be initiated either from function key 2 or from status input 2. In both cases the test condition will exist whilst the input or key is active. During the test the instrument will display the pressure value. The displayed value would be typically 80% of full range of the transducers measurement range providing there is no pressure applied to the transducer. From default, key 2 is enabled as a system test function.

Configuring the Display

Decimal Point Position

(Analogue-54)



Allow the position of the decimal point on the display to be fixed or for an auto ranging decimal point to be used. The decimal point may be fixed to give 0, 1, 2, 3 or 4 digits after the decimal point i.e. 3 decimal places would be 99.000. The default is 1 decimal place.

Display update rate

(Analogue-55)

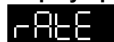

This allows the update rate of the display to be set from every 0.1 seconds to 0.5 seconds. The options are 2, 4 or 10Hz, the default setting is 2Hz.

Display Filtering

(Analogue-56)

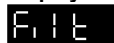

This parameter is used to set up filtering of displayed values. The time constant of the filter entered in seconds. The default value is zero (no display filtering).

Least Significant Digit Zero

(Logic-49)



When this parameter is set to ON the right hand digit only displays zero during normal running. The default is OFF.

Display Negative Numbers

(Logic-50)



This setting allows the display of negative numbers to be enabled (ON) or disabled (OFF). The default setting is ON to allow negative numbers to be displayed.

Leading Zero Suppression

(Logic-48)



Allows leading zeros to be displayed. When ON the leading zeros are not displayed. The default is ON.

Display Source

(Analogue-53)

Src Displays the source of the displayed value. InPt = from Input, Low = lowest from input, High = highest from input, Av = average from input, Comm = from comms A3 (analogue Location 3)

Brilliance

(Analogue-57)

br L Allows the brightness of the display to be adjusted to match other instruments or to suit ambient lighting conditions. The brightness may be set in the range 1 to 4, the default setting is 4 which is the highest intensity setting.

Font

(Analogue-47)

Font One of two fonts for the display of numerals may be selected to allow compatibility with some older instruments. The default font is 1.

Font 1 976 Font 2 976

Test

TEST Performs a display test which illuminates all display digits and segments (8.8.8.8.8.) when the Enter button is pressed.

Configuring Alarms

There are four alarms, each of which may be configured separately from the configuration menu. Each of the alarm configuration menu's allows you to define parameters such as the setpoint, alarm type i.e. high, low or deviation, and Hysteresis. The parameters which may be configured are described below:

Alarm Type

(Analogue-110, 125, 140, 155)

TYPE

defines the operation of the alarm, the options are none (Off), high, low and deviation. Alarm 1 and Alarm 3 are default to high and Alarm 2 and 4 default to low.

Setpoint

(Analogue-111, 126, 141, 156)

SP-1 SP-2 SP-3 SP-4

There are four setpoints one for each of the four alarms. These may be viewed and edited from the menu's or from the front panel during normal operation if this facility has been enabled (see Front Panel Edit). Each set point may be set to any value within the display range of the instrument i.e. -19999 to 99999. The default setpoints are 99999 for Alarm1 and Alarm 3 and -19999 for Alarm 2 and Alarm 4.

Deviation Setpoints

(Analogue-112, 113, 127, 128, 142, 143, 157, 158)

DEUH

DEUL

This allows the difference between the alarm setpoint and the high and low deviation levels to be defined. The default setting for both is zero. These menu options are only displayed (and valid) when the alarm type is set to deviation.

Latching

(Logic-65, 75, 85, 95)

LECH

All alarms may be set to latching (ON) or non-latched (OFF). When alarms are set to latching then the alarm indication and any associated output will remain in the active state even when the alarm condition has cleared. Latched alarms must be acknowledged to clear indications and outputs

to their inactive (non-alarm) states. There are two methods available to acknowledge an alarm:

- From the front panel by pressing the UP and DOWN arrow keys together
- By configuring one of the two status inputs as an alarm acknowledge (ACK)

The default setting is OFF (non-latching).

Note: The alarm condition must be cleared before the alarm can be acknowledged.

Output

(Logic-61-64, 71-74, 81-84, 91-94)

OP

This option will only be present in the menu for units fitted with Dual relay outputs or Quad TTL outputs. This option allows you to specify which output is activated when the alarm condition is valid. For Dual relay units the options are OP-1 (Relay 1) or OP-2 (Relay 2). For Quad TTL outputs the options are OP-1, OP-2, OP-3 and OP-4.

Delay

(Analogue-114, 115, 129, 130, 144, 145, 159, 160)

onDL

ofDL

These allow the on and off delay times for each of the alarms to be defined. The on delay defines the time, in seconds, that the alarm condition must be present before the alarm is activated. The off delay defines the time, in seconds, that the alarm condition is cleared before the alarm is deactivated (See Figure 1 below). The default setting for both the on and off delay is zero.

Hysteresis

(Analogue-116, 117, 131, 132, 146, 147, 161, 162)

onHY

ofHY

These define the difference between the set point and the point at which the alarm is activated or deactivated. The on and off Hysteresis may be specified separately above and below the setpoint. Hysteresis would normally be used to prevent the alarm being activated and deactivated repeatedly when the measured value is very close to the setpoint and there is noise present in the system (See Figure 1 below). The default values are 0.

Front Panel Edit

(Logic-66, 76, 86, 96)

Ed it

This allows you to define whether the alarm setpoints can be edited from the front panel in normal operation by the operator. When this facility is ON the operator may access the alarm setpoints from the front panel by pressing the DOWN arrow key and without having to enter the configuration menus. The default is ON.

Message Display

(Logic-67, 77, 87, 97)

d, SP

This parameter allows you to define whether alarm messages are displayed (ON) or not (OFF). The default setting is ON.

Linked Setpoints (Alarm menus 3 & 4 only)

(Logic-88,98)

L-SP

This allows you to link setpoint 3 to setpoint 1, and setpoint 4 to setpoint 2. When setpoints are linked changing setpoint 1 will automatically change setpoint 3 to the same value. Changing setpoint 2 will change setpoint 4. The default is OFF (no setpoint linking).

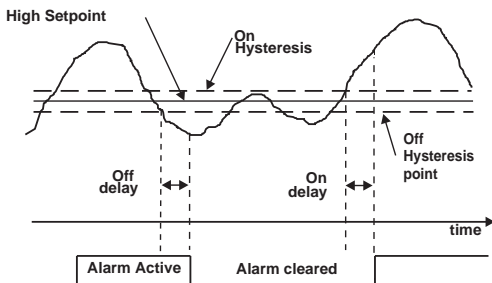
**Figure 1**

Configuring Relay / Logic Outputs (Logic-160, 165, 170, 175)

Depending on the model of your instrument you may have dual relay outputs or four open collector transistor outputs. These outputs can be configured individually to change state when an alarm or alarms are triggered. Using the output menu you can specify the sense of each of the outputs i.e. whether the relay or output transistor is energised or de-energised when the alarm(s) are triggered. This menu will only be visible on instruments when the outputs are fitted.



Selects the sense of one of the four possible outputs to either energised in the alarm condition (TruE) or de-energised in the alarm state (FLSE). The default state for all outputs are TruE. This option is found under the TyPE menu. The **PuLS** menu (Logic-161, 166, 171, 176) allows you to enable (on) or disable (oFF) the pulsing feature of the Outputs. The default is disabled. The **dELy** menu allows you to set the period of the pulse.

Configuring the Analogue Output

All instruments provide a fully scaleable and isolated analogue retransmission output which can be configured to your requirements. To configure the analogue output select **Aout** from the root menu.

Output Type

(Analogue-170)

TYPE

Allows the output operation to be set to 0 - 10V, 0 - 20mA or 4 - 20mA. The default setting is 4-20mA.

Signal Source

(Analogue-171)

SOURCE

Defines the source of the values to be retransmitted. The source can be selected from the display value (inPt), maximum or peak value (High), minimum value (LoW), Average value (Av) or a value received from the communications interface (SEr). The default is inPt.

Low Scaling Point

(Analogue-172)

LOW

Defines the **display** value at which the output will reach its minimum level i.e. 4mA (4-20mA), 0mA (0-20mA) or 0V (0-10V) dependant on analogue output type selected above. The default value is 0.

High Scaling Point

(Analogue-173)

HIGH

Defines the **display** value at which the output will reach its maximum i.e. 20mA (0 or 4-20mA) or 10V (0-10V) dependant on analogue output type selected above. The default value is 100.

Damping

(Analogue-174)

DAMP

Output damping defines the time constant in seconds for damping the output. This parameter is used to limit the rate of change of the output and may be adjusted in the range 0 to 999 seconds. The default is 0 (Off).

Configuring Serial Communications

All instruments provide a an RS485/422 compatible communications interface. The interface is designed to operate in both 2 and 4 wire (half and full duplex) communications systems. The unit supports three protocols as standard, a simple text based command set plus MODBUS™ ASCII and RTU (J-BUS).

Instrument Address (Analogue-182)

Addr

Defines the instrument address when using the instrument in a multidrop system, the range of valid addresses is 1 - 247. The default is 1.

Baud Rate (Analogue-183)

baud

Allows the speed of operation of the serial interface baud rate to be selected. The options are 1200, 2400, 4800 and 9600. The default is 9600.

Protection (Logic-102)

Prot

Allows the instrument parameter settings to be protected against change from the serial interface (write protection ON). The default is OFF.

Parity (Logic-184)

Prty

Defines parity for all communications. The options are even, odd or no parity. The default is Even

Stop Bits (Logic-103)

Stop

Defines the number of stop bits, 1 or 2. The default is 1.

MODBUS™ Options

The following three parameters are for MODBUS™ communications protocols for data scaling and resolution. Values returned from option locations i.e. Input Type, are not scaled.

Span

(Analogue-185)

The image shows a small LCD screen with the word "SPAN" in a pixelated font.

Span range used for MODBUS™ data scaling resolution. The options are 32K (32000), 32.7K (32768) and 65.5K (65535), the default setting is 32000.

Low Scaling Value

(Analogue-186)

The image shows a small LCD screen with the characters "L-P" in a pixelated font.

The display value which corresponds to 0 in a scaled MODBUS™ message. The default setting is 0.

High Scaling Value

(Analogue-187)

The image shows a small LCD screen with the characters "H-P" in a pixelated font.

The display value which corresponds to the SPAN (maximum) in a scaled MODBUS™ message. The default setting is 100.0.

Remote Terminal Unit

(Logic-104)

The image shows a small LCD screen with the characters "RTU" in a pixelated font.

If MODBUS™ RTU (sometimes known as J-BUS) protocol is required select this option ON. The default is OFF.

Transmit Delay

(Analogue-188)

The image shows a small LCD screen with the characters "DELY" in a pixelated font.

Pre transmit delay adds a delay in milliseconds, before the instrument responds to any received commands. This allows the unit to operate more reliably in two wire multidrop systems using older SCADA packages. The options for delay are 0, 100, 200 and 300mS. The default is 0 (no delay).

Master ModeThe image shows a small LCD screen with the characters "MASt" in a pixelated font.

Master Mode allows the Tracker 250 Unit to communicate with other units in the 200 Series without a request for information being received. The transmission update rate is the same as the display update rate. There are a number of sub-menus within the maSt menu. These are described below.

Enab(Logic-105)

EnAb

Turns Master Mode on or oFF. The default is oFF. Only one unit can be set in Master Mode, the others must be all slaves. When a unit is in Master Mode, all other communication features are disabled.

SorC

(Analogue-189)

SorC

Is the Memory Block from which data is being sent. If more than one block of data is being sent, then this is the first block to be accessed, the others will follow on from this block.

LoCS

(Analogue-190)

LoCS

Is the number of memory blocks to be sent. This should always be set to 1 if the unit you are sending them to is a Tracker 220.

PrE

(Logic-106)

PrE

Turns the Data Prefix on or oFF. If this option is active a short prefix will be added to the data being sent. The default is on.

dEst

(Analogue-191)

dEst

Is the memory block to which the data is being sent on the connected machine. If more than one block is being sent, then this is the first block in the sequence, the others will follow on from this block. The Default is 16.

Configuring Status Inputs

The instrument provides two status (logic) inputs which can be assigned to perform one or more functions when activated. With the exception of the Calibration function which is started when there is a transition from inactive to active state on the input, all other functions will be active only while the status input is active. The status inputs are active low i.e. placing a short circuit across the input (from a switch or relay contact) will activate the input. The following functions may be assigned to the status inputs 1 and 2:

Alarm Acknowledge (Logic-113, 126)

ACK

Clears all latched alarms which are no longer in an alarm condition. The default is OFF.

Alarm Disable (Logic-114, 127)

ADBL

Disables all alarms whilst the status input is active. The default is OFF.

Displays (Analogue-197, 201)

d, SP

Allows any one of the following to be displayed whilst the status input is active: Lamp test, the average, low or high values, or display hold. When the status input is inactive the normal measured value is displayed. The default for this is NONE.

Reset (Logic-115, 128)

rSet

This resets the High (peak), Low (minimum) and Average values to the current measured value. The default for this option is OFF.

Front Panel Keypad Disable (Logic-116, 129)

LoCK

Disables the front panel keys, the default state is OFF.

Analogue Output Hold

(Logic-117, 130)

AHld This allows the analogue output to be held (Frozen). The default state is OFF.

Auto Fast Calibration (Status input 1 only)

(Logic-120)

CAL This is used to initiate the automatic calibration process. The process is started when the status 1 input is activated. The default for this option is OFF.

Test (Status input 2 only)

(Logic-133)

TEST This facility closes the internal calibration relay, allowing the simulated high calibration point (typically 80% of the transducer range) to be checked. The default is OFF.

Status Message Display

(Logic-113, 132)

SDSP This enables or disables the display of messages related to the status input function. When ON messages are displayed alternately with value being displayed i.e. if the unit is displaying the high value, then the high value is displayed flashing with the message 'HiGH'. This indicates to the user that the current input value was not being displayed. The default is ON.

Configuring Function Keys

There are two configurable function keys:

Function key 1 

Function key 2 

The following functions may be assigned either or both keys unless stated:

Reset

(Logic-138-146)

 If ON, the function button will reset the High (Maximum), Low (minimum) and Average values to the current measured value. The default is OFF.

Auto Fast Calibration (Function key 1 only)

(Logic-141)

 If this parameter is ON then the key 1 will initiate the automatic calibration process. The default is ON.

Test (Function key 2 only)

(Logic-149)

 This facility closes the internal calibration shunt relay, allowing the simulated high calibration point (typically 80% of the transducer range) to be checked. The default is On.

Displays

(Analogue-206, 210)

 Allows any one of the following to be displayed whilst the Function key is pressed: Lamp test, the average, low or high values, or display hold. When the key is released normal display is returned. The default is NONE (no display function).

System Options

Password

PASS Password protection is enabled by entering any value between 1 and 99999. When this facility is enabled the configuration menu cannot be accessed without first entering the correct password number. The default value is 0 (No Password).

Averaging Time

(Analogue-214)

AUT Defines the averaging time the period over which the average value is calculated in seconds. It must be noted that this average value is not a true arithmetic average. The average value is simulated using an approximation based on a rolling average over the time period. The simulated average uses a filter technique. The default is 1 (second).

Default

(Logic-154)

dFLT This allows the unit to reset back to its factory default settings. Select ON to default the instrument. This parameter will automatically revert to OFF when the instrument is defaulted.

Time-out

(Analogue-215)

tout This defines the time in seconds that the unit will remain in configuration mode when there is no key activity. If there are no key presses within the specified time period the unit will return to normal operation. This facility is disabled during Calibration operations. The default time-out is 60 seconds and is adjustable between 30 to 300 seconds.

Messages

Error Messages

Err1 **Err2** **Err3** These messages indicate that an error has been detected in one of the instruments internal memory areas as part of power up self test sequence.

AdEr This indicates that the instrument has detected a fault in its measurement circuitry.

uCAL The instrument has detected a problem or error in its non volatile memory resulting in a loss of calibration data.

Note: For any of the above error messages return the instrument to the supplier.

brk The instrument has detected a problem with the sensor resulting in an open circuit input, this may be caused by a break in one of the leads from the transducer or a fault in one of the transducer elements.

over The measured value is too large positively to be displayed, or is above the specified input range.

undr The measured value is too low negatively to be displayed, or is below the specified minimum input for the selected range.

Alarm Messages

Alarm messages will be displayed alternately with the normal display only one alarm message will be displayed at any time.

LoA1 **LoA2** **LoA3** **LoA4** Low alarm has been triggered on the indicated alarm., e.g. LoA3 = Low Alarm, Alarm 3

H. A1 **H. A2** **H. A3** **H. A4** High alarm has been triggered on the indicated alarm.

Lod1 **Lod2** **Lod3** **Lod4** Deviation type alarm has been triggered on the indicated alarm at the low deviation setpoint. e.g. Lod4 = Low Deviation Alarm, Alarm 4.

H. d1 **H. d2** **H. d3** **H. d4** Deviation type alarm has been triggered on the indicated alarm at the high deviation setpoint.

Product Specification

Supply 90 - 265V AC 50/60Hz, 20VA max

Operating Conditions

Ambient Temperature Storage -10°C to 70°C
Operating - 10°C to 50°C

Humidity 10% to 95% RH Non -condensing

Input

ADC Dual Slope with auto zero

Ranges $\pm 100\text{mV}$, $\pm 20\text{mA}$ and $\pm 10\text{V}$ (Selectable)

Resolution 17bit, $1\mu\text{V}$ per display digit (mV range)

Accuracy 0.05% of reading $\pm 20\text{V}$

Update rate 10Hz

Input Impedance $> 100\text{M}\Omega$

Common mode rejection $> 150\text{dB}$

Series mode rejection $> 70\text{dB @ } 50/60\text{Hz}$

Transducer Supply

Range User Programmable 0-12V DC

Output Current 35mA maximum (limited)

Accuracy typically $\pm 50\text{mV}$

Output noise $< 10\text{mV @ } 30\text{Hz}$

Temperature drift $< 100\text{ppm}/^\circ\text{C}$

Resolution 0.01V

Analogue Output

Ranges 0-10V, 0-20mA or 4-20mA

Accuracy 0.2% of span

Temperature drift $< 100\text{ppm}/^\circ\text{C}$

Output Ripple $< 10\text{mV}$ or $50\mu\text{A @ } 30\text{Hz}$

Response 63% within 32mS
99% within 100mS

Resolution 0.05% of span, 5mV or 0.01mA

Maximum output 18V @ 25mA

Isolation	500V
Alarm Relays when Fitted	
Type	2 off changeover
Rating	1A @ 250V
Logic Outputs when Fitted	
Type	4 off optically isolated (common ground) open collector transistor outputs.
Rating	20mA , 24V
Communications Interface	
Type	EIA RS485 (RS 422 Compatible)
Display	
Type	0.56" High brightness 7 segment LED red (Optionally green)
Range	-19999 to +99999

Analogue Memory locations

(RW) = Read / Write (RO) = Read Only (WO) = Write Only

Memory Locations	Functions
Data	
0	(RO) Instrument Type e.g. 264
1	(RO) Measured Value, Unfiltered
2	(RO) Display Value, Filtered
3	(WO) Comms Display Value
16	(WO) Comms display value
Realtime	
35	(RO) Low Value
36	(RO) High Value
37	(RO) Average Value
38	(RO) unfiltered measured value
39	(RO) filtered displayed value
40	Reserved
↓	
50	Reserved
Display setup	
51	Reserved
52	Reserved
53	(RW) sorc: display source: 0=inpt,1=high,2=low,3=av,4=comm
54	(RW) dp: digits to right of decimal point; 0to 4 or 5=auto
55	(RW) rate: display update rate;0=2Hz,1=4Hz,2=10Hz
56	(RW) filt: display filter time; 0 to 999 sec (will be 0.0 to 99.9s)
57	(RW) bril: display Brilliance; 0 to 3, 3=brightest
58	Reserved
↓	

61	Reserved			
Input Setup				
62	(RW) type: 0=mV 1=mA			
63	(RW) Input Zero Point			
64	(RW) Input Full Scale Output			
65	Reserved			
66	Reserved			
↓				
71	Reserved			
Scaling - for load cell input				
72	Reserved (for user linearisation points)			
73	(RW) Ldsp: Low Cal point display value (in units of weight)			
74	(RW) L-iP: Low Cal Point input value in mV/V			
75	(RW) Hdsp: High Cal point display value (in units of weight)			
76	(RW) H-iP: High Cal point input value in mV/V			
77 - 99	Reserved (for User linearisation Cal. Points)			
Alarm Number				
1	2	3	4	
110	125	140	155	(RW) type: 0=high 1=low 2=dev 3=none
111	126	141	156	(RW) sp: septpoint -19999 to 99999
112	127	142	157	(RW) devh: deviation above sp -19999 to 99999
113	128	143	158	(RW) devL: deviation below sp -19999 to 99999
114	129	144	159	(RW) ondL: on delay 0 to 9999 s
115	130	145	160	(RW) ofdL: off delay 0 to 9999 s
116	131	146	161	(RW) onhy: on hysteresis -19999 to 99999
117	132	147	162	(RW) ofhy: off hysteresis -19999 to 99999
118	133	148	163	Reserved
↓	↓	↓	↓	

124	139	154	169	Reserved

Analog Output setup

170	(RW) type: 0=0 10V 1=0 20mA (Low_high cal point) default=2
171	(RW) sorc: 0=inpt 1=high 2=low 3=av 4=comm(a175) default=0
172	(RW) low: display value corresp.to low aout cal point. Default=0
173	(RW) high: display value corresp.to high aout cal point. Default=100
174	(RW) Damp: damping filter 0_999 s (to be: 0.0 to 99.9) default=0
175	(RW) REALTIME source of analog o/p when type=4(=comm(a175))
176	Reserved
177	Reserved

Transducer Supply Voltage

178	(RW) Transducer Supply Voltage
179	Reserved
↓	
181	Reserved

Comms Setup

182	(RO) addr: instrument address 1 247 default=1
183	(RO) baud: baud rate 0=1200 1=2400 2=4800 3=9600 default=3
184	(RO) prty: Parity 0=odd 1=even 2=none default = 1
185	(RW) span: 0=32000 1=32767 2=65535 default=0
186	(RW) L-ip: display value corresp to 0 transmission
187	(RW) H-ip: display value corresp to span t'smission default=0
188	(RW) dely: delay mS before transmit 0 3(x100mS) default=0
189	(RW) mast>sorc: analog location sent in master mode default=2
190	(RW) mast>locs: number of consecutive locs sent default=1
191	(RW) mast>dest: destination analog location on target default=16
192	Reserved

250 Series Set-up Guide

↓	
196	Reserved

Status Input Display Function				
1	2			
197	201	(RW) disp: 0=none 1=hold 2=low 3=high 4=av 6=Ltst default=0		
198	202	Reserved		
↓	↓			
200	204	Reserved		
205		Reserved		
Function Key Display Function				
1	2			
206	210	(RW) disp: 0=none 1=hold 2=low 3=high 4=av 5=Ltst		
207	211	Reserved		
↓	↓			
209	213	Reserved		
214		(RW) Avti: Period in seconds over which average is taken default=1		
215		(RW) tout: keypad inactivity timeout to Conf mode exit default=60		
216		Reserved		
↓				
218		Reserved		
Relay/TTL O/p setup				
219	221	223	225	(RW) puls:dely 0.1 to 4.9 secs default=0.5s
220	222	224	226	Reserved

Logic Memory locations

(RO)=Read Only (WO)=Write Only (RW)=Read/Write

Memory location	Function
Realtime Info	
6	(RO) function key1 (leftmost) state: ON=Pressed
7	(RO) function key2 (rightmost) state: ON=Pressed
8	(RO) status input1 state: ON=connected
9	(RO) status input2 state: ON=connected
10	(RO) alarm1 state: ON=activated
11	(RO) alarm2 state: ON=activated
12	(RO) alarm3 state: ON=activated
13	(RO) alarm4 state: ON=activated
NOTE: Relay/TTL O/Ps are only relevant if the outputs are fitted. If they are then they ignore relay inversion and relay pulse action	
14	(RO) output1 (relay/TTL) state: ON=closed/activated
15	(RO) output2 (relay/TTL) state: ON=closed/activated
16	(RO) output3 (relay/TTL) state: ON=closed/activated
17	(RO) output4 (relay/TTL) state: ON=closed/activated
18	Reserved
↓	
23	Reserved
24	(RO) calibration in progress: ON=busy
Runtime Control	
25	(RW) ON=Do FastCal. Repeat when clear while L24 ON.
26	(RW) ON=Alarm Acknowledge
27	(RW) ON=Reset high, Low,av
28	(RW) ON=Reset High display value only
29	(RW) ON=Reset Low display value only
30	(RW) ON=Reset Average display value only
31	(RW) ON=Perform Zero
32	(RW) ON=Reset Zero

33	(RW) ON=Perform Tare
34	(RW) ON=Un-Tare
35	Reserved
↓	
41	Reserved
Scaling Control	
42	(RW) ON=read L-iP (reads OFF when done -see also L44)
43	(RW) ON=read H-iP (reads OFF when done - see also L44)
44	(RW) ON=re-scale. Do when L-iP, H-iP,Hdsp and Ldsp are ALL as required
45	Reserved
46	Reserved
Display setup	
47	(RW) font:ON=Display font2, OFF=Display font1 default=OFF
48	(RW) 0sup: ON=Leading zeros blank OFF=Leading zeros on default=ON
49	(RW) Lsd0: ON=Least signif. digit 0 OFF=normal default=OFF
50	(RW) neg: ON=neg display enable OFF=neg values show 0 default=ON
51	Reserved
↓	
54	Reserved
Input Setup	
55	(RW) Mains Frequency 0=50Hz 1=60Hz
56	Reserved
57	Reserved
58	Reserved
59	Reserved
60	Reserved

Alarm setup				
Al-1	Al-2	Al-3	Al-4	Function
61	71	81	91	(RW) O/P:1---: ON=relay/TTL-O/p1 set by alarm Default=OFF
62	72	82	92	(RW) O/P:-2--: ON=relay/TTL-O/p1 set by alarm Default=OFF
63	73	83	93	(RW) O/P:--3-: ON=relay/TTL-O/p1 set by alarm Default=OFF
64	74	84	94	(RW) O/P:---4: On=relay/TTL-O/p1 set by alarm Default=OFF
65	75	85	95	(RW) LtcH: ON=Latching Default=OFF
66	76	86	96	(RW) Edit: ON=Panel Key edit enabled Default=OFF
67	77	87	97	(RW) disp: ON=Warning Message Default=ON
68	78			Reserved
		88	98	(RW) L-SP: ON=Linked to Alarm minus 2 default=OFF
69	79	89	99	Reserved
70	80	90	100	Reserved
Comms setup				
101		(RW) ON=7 digits values from instrument OFF=5 digits Default=OFF		
102		(RW) Prot: ON=all analog/logic locations write protected Default=OFF		
103		(RO) StoP: ON=2 stop bits OFF=1 stop bit		
104		(RO) rtu:ON=binary MODBUS™ RTU/JBUS comms Protocol. Default=OFF		
105		(RW) mASt: ON=instrument is master (Consatntly transmits) Default=OFF		
106		(RW) PrE: ON=master Transmissions prefixed with ;001SA16 Default=ON		
107		Reserved		
↓				

111		Reserved
Status Input setup		
112	125	(RW) tArE: ON=tare display Default=OFF
113	126	(RW) Ack: ON=acknowledge all latched alarms Default=OFF
114	127	(RW) AdbL: ON=disable alarms
115	128	(RW) rSEt: ON=reset high/low/av/ Default=OFF
116	129	(RW) Lock: ON=disable front panel keys Default=OFF
117	130	(RW) hOLd: ON=hold the analogue output value Default=OFF
118	131	(RW) ZerO: ON=zero display Default=OFF
119	132	(RW) disP: ON=show Status message(s) Display Default=OFF
120	133	(RW) CAL: ON=begin fast cal (need>1 Activation Default=OFF
121	134	Reserved
↓	↓	
124	137	Reserved
Function Key Setup		
1 (⌂)	2 (*)	Function
138	146	(RW) rSEt: ON=reset high/low/av/ default=OFF
139	147	(RW) tArE: ON=tare display
140	148	(RW) ZerO: ON=zero display
141	149	(RW) CAL: ON=do fastcal (need more than 1 activation) default=OFF
142	150	Reserved
↓	↓	
145	153	Reserved
System setup		
154		(RW) dFLt: ON=default instrument setup
155		(RW) rSEt: ON=Reset instrument (as on power up)
156		Reserved

↓				
159	Reserved			
Relay/TTL Output Setup				
160	165	170	175	(RW) tyPE: ON=true OFF=false(inverted) Default=ON
161	166	171	176	(RW) PuLS.EnAb: ON=pulsed OFF=normal Default=OFF
162	167	172	177	Reserved
163	168	173	178	Reserved
164	169	174	179	Reserved